



**HITACHI**  
Inspire the Next

Vacuum Cleaner

**HITACHI**  
Inspire the Next

AUTHENTICALLY  
**Japan Made**



The Hitachi Story



# The Hitachi Story

True to its hallmark history and philosophy of innovation, Hitachi has continuously created vacuum cleaners to meticulous detail. From specially-engineered pipe and hose that enable superior operation and mobility, to the combined genius of multi-angle head and zoom pipe that enable access to seemingly-impossible corners, nothing is overlooked. Our latest model also has a unique suction Electric Linen Beat Head that captures allergens deeply entrenched in fabrics. Nothing escapes us.



1992

## Infrared Remote Control

The use of "Infrared Remote Control" eliminates the need for a core wire in both pipe and hose, thereby offering superior operability and lightness.



1999

## One-touch Zoom Pipe

Length of the pipe is easily adjusted using the hand lever. A longer pipe ensures stairs or areas under a table are conveniently cleaned.



2009

## Two Boost Cyclonic System

Suction force can be maintained for a long time through dual-stage air acceleration (boost) and use of the cyclone force generated.

1997

## Multi Angle Head

The head can turn either left or right effortlessly in a single twist. In doing so, narrow areas and gaps can be easily vacuumed.



2006

## Quick Dust Disposal Case

This pioneering technology enables all accumulated rubbish to be disposed directly into a dust case through a one-touch function. Controls the swirling of dust during disposal.



2011

## Carbon Light Head & Extension Pipe

Use of carbon fiber-reinforced plastic in the extended pipe and head maintain its strength while keeping it slim and lightweight.



CV-SA8200RJ

## Allergy Care



### Electric Linen Beat Head

A special plate in the head beats the linen to lift up allergens hidden deep in fabrics such as sofa and bedding linen.



CV-SA8100RJ

## Smooth & Easy



### Motorized Auto Drive Head

Thanks to Hitachi original motorized head design, the suction head moves by itself when the power is on, and picks up dust with less effort.



CV-SA8000RJ

## Hygienic



### Dust Collection Efficiency 99.999%

High dust collection performance filter effectively captures allergens like pollen and even fine dirt.

# Allergy Care



## How is dust present on your mattress?

Dust includes dropping and carcass of mites, pollen, human hair and etc. is accumulated and it lies hidden in between your mattresses which cannot be seen.

### Electric Linen Beat Head



Thoroughly vacuums house dust with the electric linen beat head.



The whole surface area vibrates and beats thoroughly.

Easy to control as the large wheels move forward quickly without sticking to the mattress.

### Motorized Auto Drive Head

Thanks to Hitachi original motorized head design, the suction head moves by itself when the power is on, and picks up dust with less effort.



### Easy maintenance with "One-touch removal"

Both rotating brush and long roller can be removed/detached easily and washed with water. Even tangled dust can be removed easily.



Pull the lever to remove the brush holder

Easy to remove/detach rotating brush

Can be washed with water!



Even when pulling back, suction power remains strong to clean thoroughly



Strong and light carbon fiber is used for the head

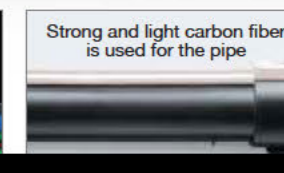

Strong and light carbon fiber is used for the pipe

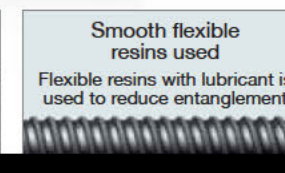

Smooth flexible resins used

Flexible resins with lubricant is used to reduce entanglement

## Allergy Care



Motorized Auto Drive Head



Electric Linen Beat Head



CV-SA8200RJ

- Two Boost Cyclonic Technology
- Easy Dust Disposal System
- Low Noise Operation

# Smooth & Easy



## Smart Head

### Motorized Auto Drive Head

Thanks to Hitachi original motorized head design, the suction head moves by itself when the power is on, and picks up dust with less effort.



### 4-Way Suction

Side blade ensures dust is vacuumed from both sides. Also, long roller rotates as vacuum head is pulled along, sucking in dust from its rear. Vacuum head is approximately 30cm wide, lightweight and compact. Its powerful automated operation makes cleaning much easier.



Moves forward powerfully, and pulls back easily



Even when pulling back, suction power remains strong to clean thoroughly

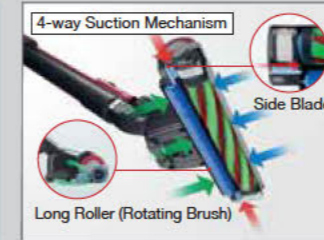

4-way Suction Mechanism

Side Blade

Long Roller (Rotating Brush)

### Easy maintenance with "One-touch removal"

Both rotating brush and long roller can be removed/detached easily and washed with water. Even tangled dust can be removed easily.

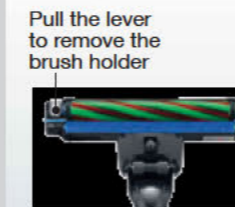

Pull the lever to remove the brush holder

Easy to remove/detach rotating brush



Can be washed with water!

## Carbon Light Head and Extension Pipe

Having a light head and pipe, and being easy to grip and lift up makes cleaning easy over step stairs and staircases. Head also rises and changes directions easily.



Light & Easy to Maneuver



The thick grip end fits your hand perfectly, making it easy to hold.

The straight hand grip is firm and easy to lift.

## Extendable Multi Angle Wide Brush

Easy and thorough cleaning even in high or narrow spaces.



A quick-change to a wide brush with one smooth swivel



For above curtain boxes



For ceiling ventilation ducts



For narrow spaces

## Smart Hose

As the hose is thin and light, cleaning is easy with little strain on the arm even when lifting up to clean. Entanglement with furniture is reduced, making it easy to maneuver.



Flexible Movement

## Smooth & Easy



Motorized Auto Drive Head



Extendable Multi Angle Wide Brush



CV-SA8100RJ

- Two Boost Cyclonic Technology
- Easy Dust Disposal System
- Low Noise Operation

# Hygienic



## Clean Exhaust

Measured in compliance with International Electrotechnical Commission (IEC) 60312-1:2010 (ed.1)

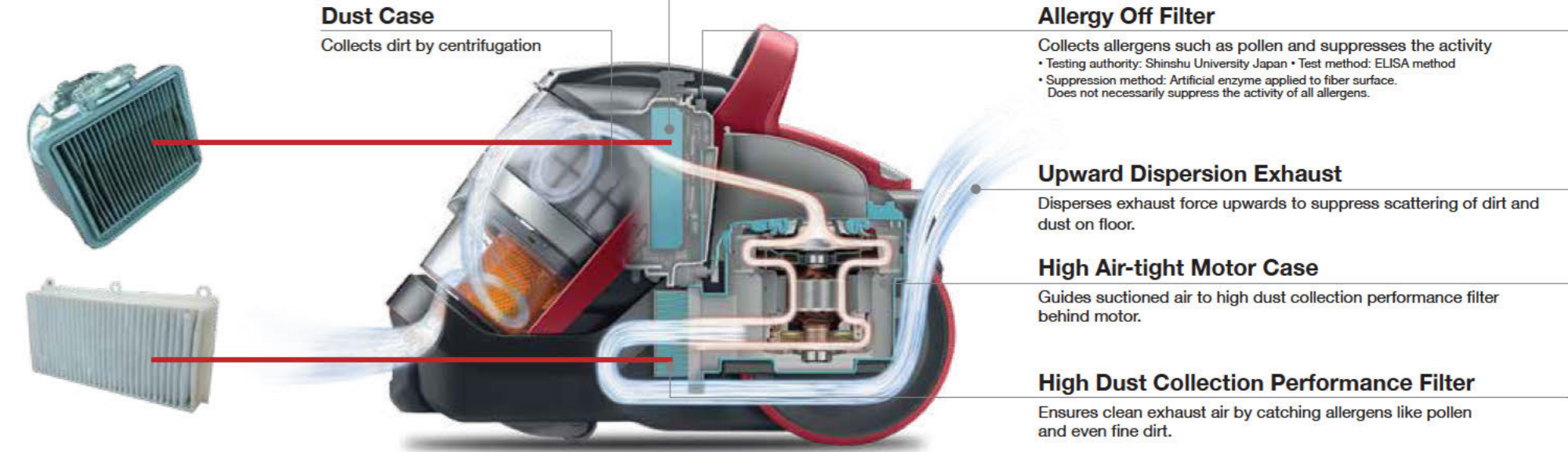

### Prevents 99.999% of suctioned dirt from escaping

Collection performance was measured by third party authorities SLG (Germany) in accordance with IEC (International Electrotechnical Commission).  
\* 1 micrometer is 0.001 millimeter

Test dirt	Test authority	Test method	Test results
AC dust (fine)	SLG (Germany)	Measurement of 0.3 to 10µm dust and dirt amounts	Dust Collection Efficiency (average) 99.999%

## Air Turbine Head

Power of indrawn air makes brush spin which beats dust out of the carpet.



### Cleans to the edge in front and sides

Draws in dust from front and sides to vacuum even corners of the room and wall edges.

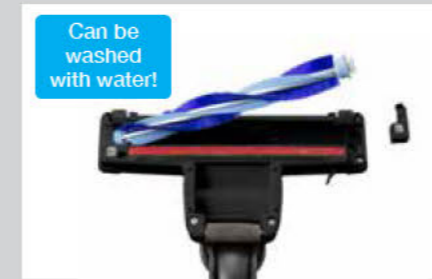

### Easy to detach/remove

Brush holder detaches when you open the lever and you can remove the spinning/rotating brush.

Can be washed with water!

## Hygienic



Air Turbine Head



Dust Collection Efficiency 99.999%

- Two Boost Cyclonic Technology
- Easy Dust Disposal System
- Low Noise Operation



CV-SA8000RJ

# Sustainable\* suction power Sustainability above 99%\*\*

\* The new standard is labeling based on the "suction power sustainability measurement of electric vacuum cleaners", a voluntary standard established by the Japan Electrical Manufacturers' Association.  
\*\*The sustainability of airflow from the state of no dirt in the filter and dust box to the line indicating time to empty dirt in the dust box is above 99%.

## Easy Dust Disposal

### Dirt is compressed by second tier boost

Airflow is boosted (accelerated) at the cyclone chamber entrance, and the generated cyclone centrifuges dirt and air.

Centrifuged dirt and air are reaccelerated at the dust box entrance. Dirt is compressed by the generated cyclone.

#### Centrifuges dirt and air

#### Dirt and air

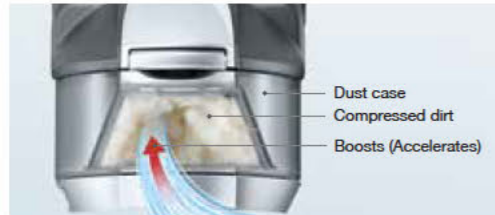
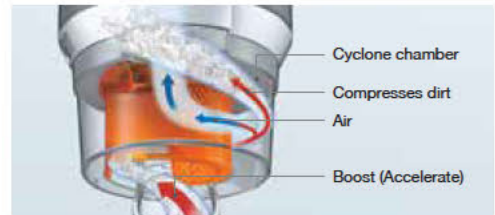

## Multi Angle Head

### Free Moving

The head rotates 90° to the left & right, ensures smooth cleaning along the wall, in narrow areas & spaces.



Head turns 90° to the left & right



## Quick Dust Disposal Case

### Easy to empty

Press the dirt disposal button to open the lid to allow the accumulated dirt inside to be disposed off easily.



Full-flat structure  
Comparison between mounted head & unmounted head.

\*Product image is for Japan market only and different from actual product.

# Powerful Suction 400W

## Powerful yet quiet

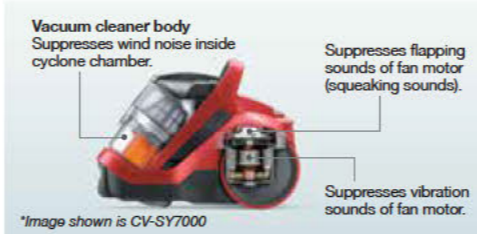
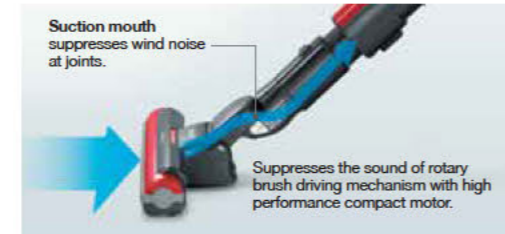

## Both dust case & filter are easy to clean

Because the cyclone has a simple 2-tier structure, it is easy to clean.



## Prevents clogging of filter (Self filter maintaining/cleaning system)

Pulling the power cord vibrates the clean filter and shakes off the dirt, thereby minimizing clogging of filter.



## One-touch zoom pipe

Pipe length can be easily adjusted with just one hand.



## Quick storage

Just hook to store easily.



## One-touch swivel brush



## Quick carrying handle



Attach to extension pipe and grip for easy cleaning.

Easy to carry around.

# SPECIFICATIONS

	CV-SA8200RJ	CV-SA8100RJ	CV-SA8000RJ
	<b>CARBON Light</b> <b>SMART HOSE</b>	<b>CARBON Light</b> <b>SMART HOSE</b>	<b>CARBON Light</b> <b>SMART HOSE</b>
Motor Max. Power (W)	1,400	1,400	1,400
Suction Power (W)	400	400	400
Dust Capacity (L)	0.4	0.4	0.4
Noise Level (dB)	59	59	61
Dust Collection Efficiency (%)	99.8	99.8	99.999
Long Lasting Suction	Auto Suction Booster	Auto Suction Booster	Auto Suction Booster
Head	Auto Drive Head Electric Linen Beat Head	Auto Drive Head Extendable Multi Angle Wide Brush	Powerful Air Head
Body	Carbon Light	Carbon Light	Carbon Light
Hose	Smart Hose	Smart Hose	Smart Hose
Extension Pipe	Carbon Light	Carbon Light	-
Unique Features	Multi Angle Head, Flat Mechanism, Quick Dust Disposal, One-Touch Zoom Pipe, Quick Storage, Handy & Easy Remote Control		
Accessories	One-Touch Swivel Brush, Quick Carrying Handle, Crevice Nozzle, Maintenance Brush		
Net Weight (kg) / Gross Weight (kg)	5.9/ 7.1	5.6/ 7.1	4.8/ 6.3
Dimension: L x W x H mm	405 x 268 x 313	405 x 268 x 313	405 x 268 x 313
Colour	Champagne	Ruby Red	Red

Hitachi Sales (Malaysia) Sdn. Berhad (11543-v) Customer CareLine: 1 800 88 1122  
Website www.hitachiconsumer.com.my | Email marketing.hsm.tf@hitachi.com | Mon Fri 9:00am - 5:45pm

